

**WARNING:** This product contains chemicals, including lead, known to the State of California to cause birth defects or other reproductive harm. ***Wash hands after handling.***

**WARNING:** This product has a lamp which contains a very small amount of mercury. Dispose of it as required by local, state, or federal ordinances and regulations. For more information, see **[www.eiae.org](http://www.eiae.org)**

This entire user's guide is available on the enclosed CD as an Adobe Acrobat pdf file in the following languages: English, French, German, Italian, Norwegian, Portuguese, Spanish, Russian, Japanese, Korean, Traditional Chinese, Simplified Chinese. Before using this projector, please read these instructions.

Le mode d'emploi complet est disponible sur le CD joint sous forme de fichier pdf d'Adobe Acrobat dans les langues suivantes : anglais, français, allemand, italien, norvégien, portugais, espagnol, russe, japonais, coréen, chinois traditionnel, chinois simplifié. Avant d'utiliser ce projecteur, veuillez lire ces instructions.

Die vollständige Benutzeranleitung ist auf der im Lieferumfang enthaltenen CD als Adobe Acrobat PDF-Datei in den folgenden Sprachen verfügbar: Englisch, Französisch, Deutsch, Italienisch, Norwegisch, Portugiesisch, Spanisch, Russisch, Japanisch, Koreanisch, Traditionelles Chinesisch und Vereinfachtes Chinesisch. Bitte lesen Sie diese Anweisungen vor der Verwendung des Projektors.

La presente guida è disponibile sul CD allegato, come file Adobe Acrobat pdf, nelle seguenti lingue: inglese, francese, tedesco, italiano, norvegese, portoghese, spagnolo, russo, giapponese, coreano, cinese tradizionale e cinese semplificato. Prima di usare questo proiettore, leggere le seguenti istruzioni.

Hele denne brukerhåndboken finnes på den vedlagte CD-en som en Adobe Acrobat pdf-fil på følgende språk: Engelsk, fransk, tysk, italiensk, norsk, portugisisk, spansk, russisk, japansk, koreansk, tradisjonell og forenklet kinesisk. Les disse anvisningene før projektoren tas i bruk.

Este guia do usuário completo está disponível no CD anexo, como um arquivo pdf do Adobe Acrobat nos seguintes idiomas: inglês, francês, alemão, italiano, norueguês, português, espanhol, russo, japonês, coreano, chinês tradicional, chinês simplificado. Antes de utilizar este projetor, leia estas instruções.

Este manual de uso está disponible en su totalidad en el CD incluido, como archivo pdf de Adobe Acrobat, en los siguientes idiomas: inglés, francés, alemán, italiano, noruego, portugués, español, ruso, japonés, coreano, chino tradicional, chino simplificado. Antes de usar el proyector, lea estas instrucciones.

Данное руководство пользователя в полном объеме представлено на прилагаемом компакт-диске в виде pdf-файла Adobe Acrobat на следующих языках: английском, французском, немецком, итальянском, норвежском, португальском, испанском, русском, японском, корейском, традиционном и упрощенном китайском. Перед использованием проектора, прочитайте данные инструкции.

このユーザーズガイドは、プロジェクタに付属しているCDにAdobe AcrobatのPDFファイル形式として収録されています。次の言語のユーザーズガイドをご利用いただけます。英語、フランス語、ドイツ語、イタリア語、ノルウェー語、ポルトガル語、スペイン語、ロシア語、日本語、韓国語、簡体中国語、繁体中国語。このプロジェクタを使用する前に、ユーザーズガイドを必ずお読みください。

附带的 CD 上有 Adobe Acrobat pdf 格式的整本《使用者指南》，包括下列各种语言版本：英文、法文、德文、意大利文、挪威文、葡萄牙文、西班牙文、俄文、日文、韩文、繁体中文、简体中文。请在使用投影机之前，先阅读这些说明。

所附的光碟片上，有 **Adobe Acrobat (PDF)** 格式的這本《使用者手冊》；所提供的不同語言版本包括：英文、法文、德文、義大利文、挪威文、葡萄牙文、西班牙文、俄文、日文、韓文、中文繁體、以及中文簡體。開始使用本投影機之前，請先詳細閱讀這些說明。

동봉된 CD에는 Adobe Acrobat pdf 파일 형식의 사용 설명서가 영어, 프랑스어, 독일어, 이탈리아어, 노르웨이어, 포르투갈어, 스페인어, 러시아어, 일본어, 한국어, 중국어(번체 및 간체)로 제공됩니다. 이 프로젝터를 사용하기 전에 다음 지침을 읽으십시오.

## Declaration of Conformity

Manufacturer: InFocus Corporation, 27700B SW Parkway Ave. Wilsonville, Oregon 97070 USA

European Office: Strawinskylaan 585, 1077 XX Amsterdam, The Netherlands

We declare under our sole responsibility that this projector conforms to the following directives and norms:

EMC Directive 89/336/EEC, Amended by 93/68/EEC

EMC: EN 55022

EN 55024

EN 61000-3-2

EN 61000-3-3

Low Voltage Directive 73/23/EEC, Amended by 93/68/EEC

Safety: EN 60950: 2000

February, 2004

## Trademarks

Apple, Macintosh, and PowerBook are trademarks or registered trademarks of Apple Computer, Inc. IBM is a trademark or registered trademark of International Business Machines, Inc. Microsoft, PowerPoint, and Windows are trademarks or registered trademarks of Microsoft Corporation. Adobe and Acrobat are trademarks or registered trademarks of Adobe Systems Incorporated. InFocus, ProjectorNet, LiteShow, and LP are trademarks or registered trademarks of InFocus Corporation.

## FCC Warning

This equipment has been tested and found to comply with the limits for a Class A digital device, pursuant to part 15 of the FCC Rules. These limits are designed to provide reasonable protection against harmful interference when the equipment is operated in a commercial environment. This equipment generates, uses, and can radiate radio frequency energy and, if not installed and used in accordance with the instruction manual, may cause harmful interference to radio communications. Operation of this equipment in a residential area is likely to cause harmful interference in which case the user will be required to correct the interference at his own expense.

## EN 55022 Warning

This is a Class A product. In a domestic environment it may cause radio interference, in which case the user may be required to take adequate measures. The typical use is in a conference room, meeting room or auditorium.

## Canada

This Class A digital apparatus complies with Canadian ICES-003.

Cet appareil numérique de la classe A est conforme à la norme NMB-003 du Canada.

## Agency Approvals

UL, CUL, TUV, GOST

Other specific Country Approvals may apply, please see product certification label.

This user's guide applies to models C410, C420, GEN300, and GEN301.

InFocus reserves the right to alter product offerings and specifications at any time.

## Remote Control Warning

Laser radiation class II product; wavelength 650nm; maximum output 1mW. Remote control complies with applicable requirements of 21 CFR 1040.10 and 1040.11.

Remote control complies with applicable requirements of EN 60 825-1: 1994 +A11.

**Do not look into the laser beam emitted from the front of the remote control.**



## Table of Contents

Introduction	5
Connecting a computer	7
Required computer connections	7
Displaying a computer image	9
First-time projector use with Windows 98	10
Adjusting the image	12
Connecting a video device	13
Displaying a video image	14
Shutting down the projector	16
Troubleshooting your setup	16
Using the keypad buttons	24
Using the remote control	25
Using the audio	26
Optimizing computer images	27
Presentation features	27
Optimizing video images	28
Customizing the projector	28
Using the menus	29
Picture menu	30
Settings menu	33
Maintenance	37
Cleaning the lens	37
Changing the lens	37
Replacing the projection lamp	38
Cleaning the dust filter	40
Using the security lock	40
Appendix	41
Accessories	41
Red LED behavior and projector errors	42
Projected image size	42

If you are experienced in setting up presentation systems, use the included *Quick Set Up* card. For complete details on connecting and operating the projector, refer to this User's Guide. Electronic versions of this User's Guide in multiple languages are available on the included CD and on our website.

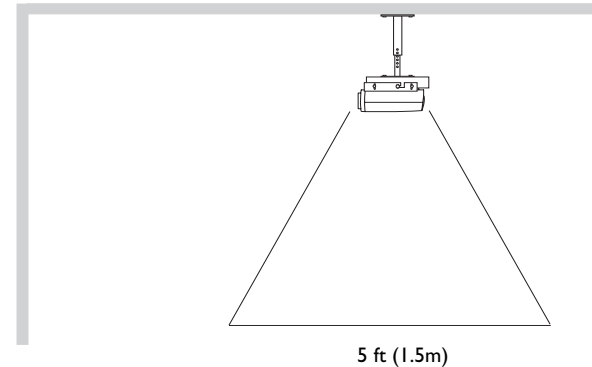
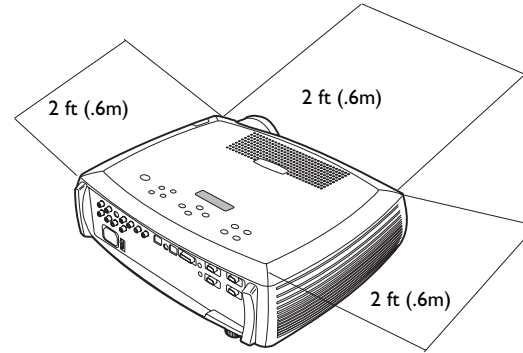
The website also has technical specifications (an interactive image size calculator, laptop activation commands, connector pin outs, a glossary, the product data sheet), a web store to buy accessories, and a page for online registration. See the inside of the back cover for a list of all relevant web addresses.

## Important Operating Considerations for Safety

- Place the projector in a horizontal position no greater than 15 degrees off axis.
- Locate the projector in a well-ventilated area without any obstructions to intake or exhaust vents. Do not place the projector on a tablecloth or other soft covering that may block the vents.
- Locate the projector at least 4' (1.2 m) away from any heating or cooling vents.
- Use only InFocus-approved ceiling mounts.
- Use only the power cord provided. A surge-protected power strip is recommended.
- Refer to this manual for proper startup and shutdown procedures.
- In the unlikely event of the lamp rupturing, discard any edible items placed in the surrounding area and thoroughly clean the area along all sides of the projector. Wash hands after cleaning the area and handling the ruptured lamp. This product has a lamp which contains a very small amount of mercury. Dispose of it as required by local, state or federal ordinances and regulations. For more information see [www.eiae.org](http://www.eiae.org).

Follow these instructions to help ensure image quality and lamp life over the life of the projector. Failure to follow these instructions may affect the warranty. For complete details of the warranty, see the Warranty section at the end of this user's guide.

Do not place objects in the areas along the side and in the front of the projector



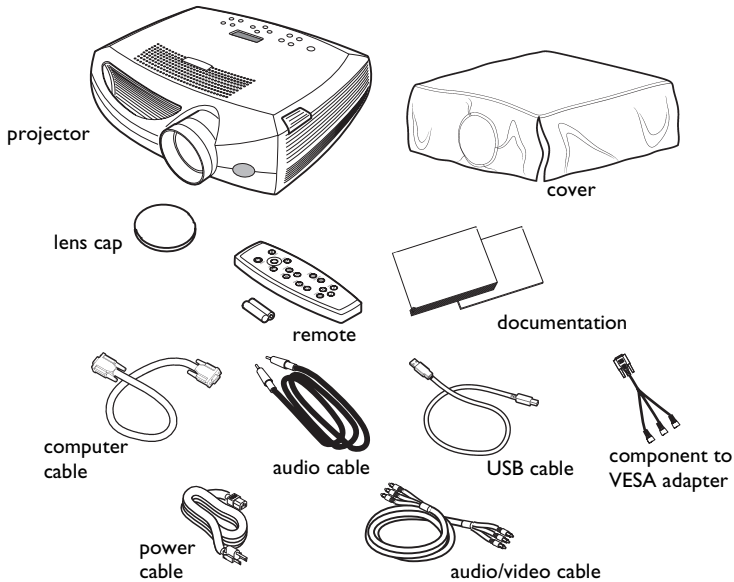
# Introduction

Your new digital projector provides three computer and three video inputs and has XGA 1024x768 resolution. Optional user-changeable short and long throw lenses make this a flexible product suitable for many different uses. The projector is easy to connect, easy to use, easy to maintain. An Interactive Display on the top of the projector gives you constant feedback on the status of the projector.

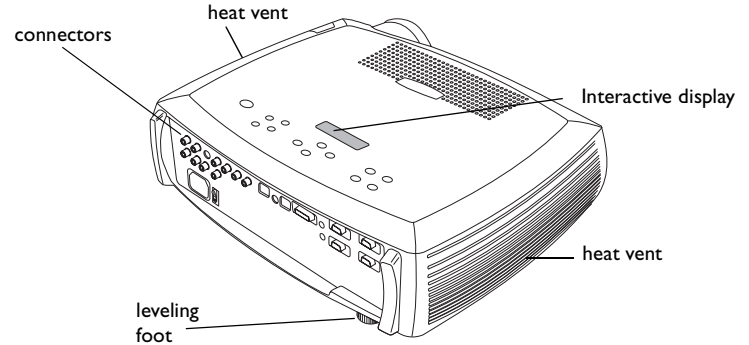
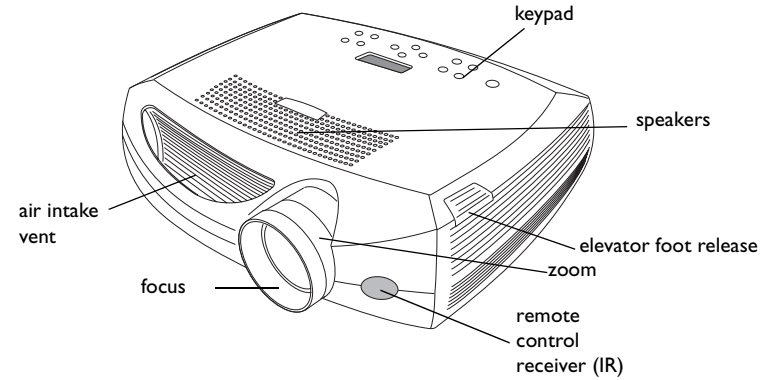
## Online Registration

Register your projector on our website to receive product updates, announcements, and registration incentives. See the inside of the back cover for the web address.

## Included items



# Projector components and features



## Connector Panel

The projector provides three computer and three video connectors:

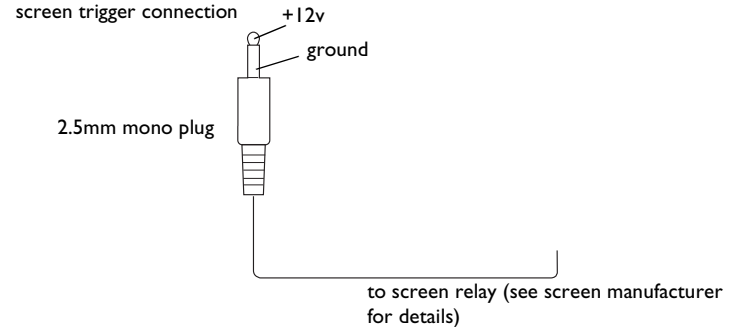
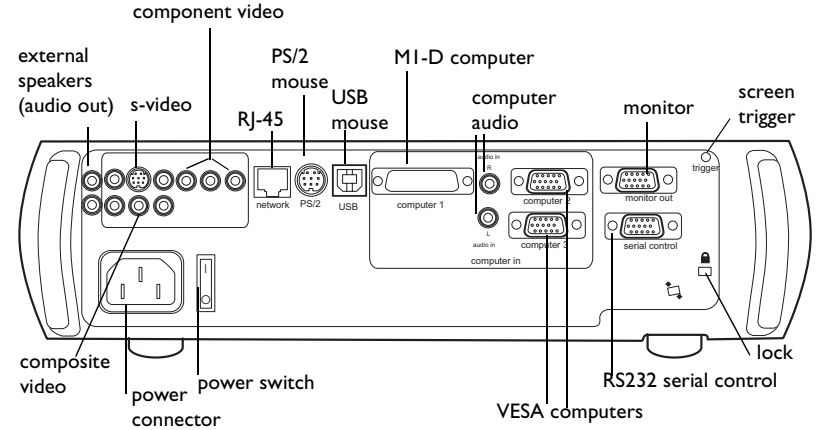
- one M1-D (HD, DVI, and computer)
- two VESA (HD, HD component, and computer)
- one component RCA
- one S-video
- one composite RCA
- one USB mouse (for use with the Computer 2 input only)
- one PS/2 mouse (for use with the Computer 3 input only)

It also has an RS-232 serial connector for serial control and an RJ-45 connector for networked control via ProjectorNet software. The Command Line Interface (CLI) specifications and commands are on our website.

A 2.5 mm mini-jack trigger provides a 12 volt DC output. It provides a constant output while the projector is on. If you connect your projection screen to the trigger with an optional cable, when you turn on the projector the screen will move down; when you turn the projector off, the screen will return to the storage position. You must turn this feature on in the System menu to use it. See page 34.

## Wireless Projection

You can use the projector's M1 connector along with the InFocus® LiteShow® wireless adapter and software for cable-free digital projection. Contact an authorized InFocus dealer or visit the website listed on the back inside cover of this User's Guide for more information.



**InFocus. LiteShow.**  
Wireless Freedom for Your Projector.™



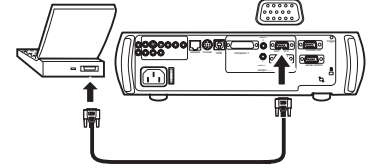
# Connecting a computer

## Required computer connections

Connect one end of the computer cable to the **Computer 2** connector on the projector. Connect the other end to the video port on your computer. If you are using a desktop computer, you first need to disconnect the monitor cable from the computer's video port.

Some Macintosh computers do not have a standard VESA-out video port. If the supplied computer cable will not connect to your computer, purchase the appropriate adapter from your Apple reseller.

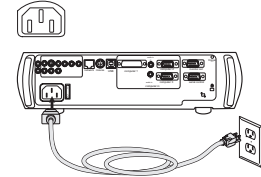
connect computer cable



Connect the black power cable to the connector on the back of the projector and to your electrical outlet.

**NOTE:** Always use the power cable that shipped with the projector.

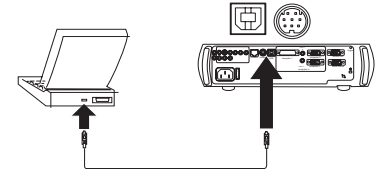
connect power cable



## Optional computer connections

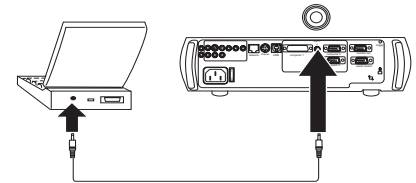
To control your computer's mouse using the projector's remote control, connect the USB cable to the **USB** connector on the projector and on your computer. USB drivers must be installed to use the USB feature. For more information, see page 11. If your computer has a PS/2 connector, connect an optional PS/2 cable to the **PS/2** connector on the projector and on your computer. The USB input is for Computer 2, the PS/2 input is for Computer 3.

connect USB or PS/2 cable



To have sound with your presentation, connect the audio cable to your computer and to the computer **Audio In** connector on the projector.

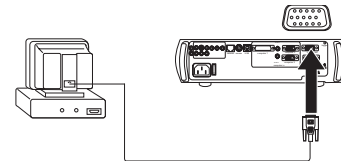
connect audio cable





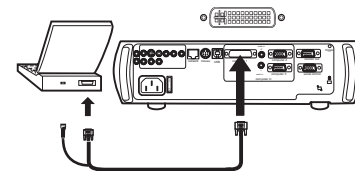
If you are using a desktop computer and want to see the image on your computer screen as well as on the projection screen, plug the monitor cable to the **Monitor out** connector on the projector.

connect monitor cable



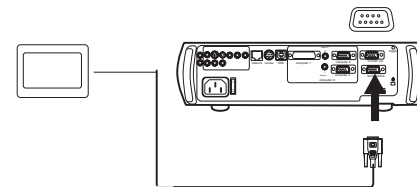
If you prefer connecting your computer to the projector with an optional M1-D cable, connect one end of that cable to the M1 port on your computer, and connect the other end to the **Computer I** connector on the projector.

connect M1-D cable



You can control the projector from an LCD control panel or computer by connecting an RS-232 cable to the projector's **Serial** connector. Specific RS-232 commands can be found in the Service and Support section of our website.

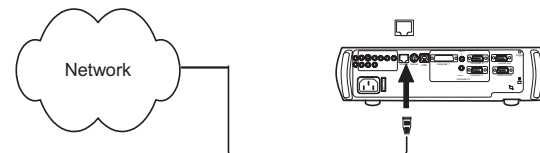
connect RS-232 cable



The projector can be managed by ProjectorNet networking software through its **Network** connector.

Contact an authorized dealer or visit our website for information on ProjectorNet.

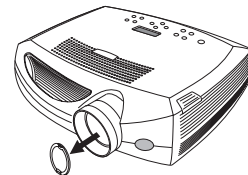
connect network cable



## Displaying a computer image

Remove the lens cap.

remove lens cap



Press the power switch to position “1” on the back of the projector, then press the **Power** button on the top of the projector or the remote.

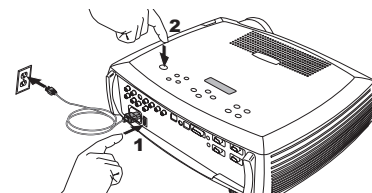
The LED flashes green and the fans start to run. When the lamp comes on, the startup screen is displayed and the LED is steady green. It can take a minute for the image to achieve full brightness.

**? No startup screen?** Get help on page 17.

press Power switch



press Power button



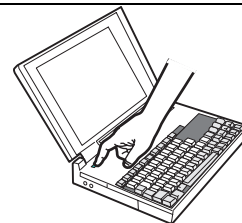
Turn on your computer.

The computer’s image should appear on the projection screen. If it doesn’t, press the **Computer** button on the projector’s keypad.

turn on computer



computer

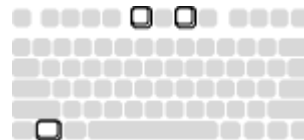


Make sure your laptop’s external video port is active.

Many laptops do not automatically turn on their external video port when a projector is connected. Usually a key combination like FN + F5 is used to turn the external display on and off. Refer to your computer’s documentation to learn your computer’s key combination.

**? No computer image?** Try pressing the **Auto Image** button on the keypad. Get help on page 17.

activate laptop’s external port



## First-time projector use with Windows 98

The first time you connect a computer running Windows 98 to the projector, the computer recognizes the projector as “new hardware” and the Add New Hardware Wizard appears. Follow these instructions to use the Wizard to load the correct driver (which was installed with your Windows operating system).

If you are running Windows 2000, Windows ME, or Windows XP, skip these steps and go to “Adjusting the image” on page 12.

**a** Click **Next** to begin searching for the driver.

**b** Make sure “Search for the best driver” is selected, then click **Next**.

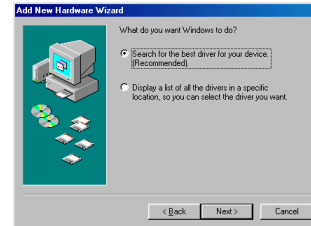
**c** Uncheck any checked boxes, then click **Next**. Windows automatically locates the driver. If this driver has been removed, reload the driver using your Windows operating system CD.

**d** When Windows finds the driver, you are ready to install it. Click **Next**.

**a**



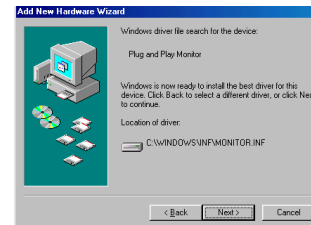
**b**



**c**



**d**



## **Skip this page if you did not connect a USB mouse cable**

### **For Windows 98:**

- If you connected the USB cable, the Add New Hardware Wizard appears again. Drivers must be installed to use the USB functionality.
- **The Wizard launches two times.**

The first time it detects a USB Human Interface Device (for the keyboard).

The second time it detects a USB Human Interface Device (for the mouse).

### **For Windows 2000, Windows ME, and Windows XP:**

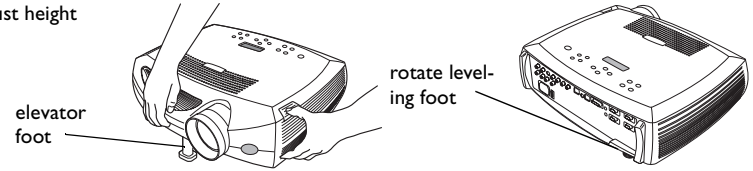
- The USB drivers are automatically installed.

## Adjusting the image

Adjust the height of the projector, if necessary, by pressing the release button to extend the elevator foot.

Rotate the leveling foot (located at the bottom back right corner), if necessary.

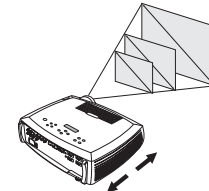
adjust height



Position the projector the desired distance from the screen at a 90 degree angle to the screen.

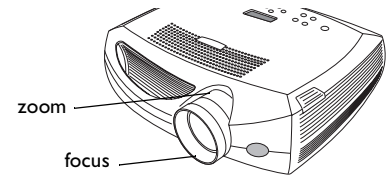
See page 42 for a table listing screen sizes and distances.

adjust distance



Adjust the zoom or focus rings by rotating them until the desired image size and focus are produced.

adjust zoom and focus

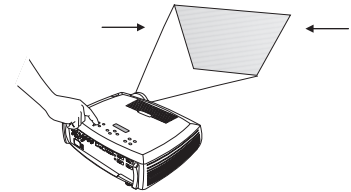


If the image is not square, adjust the vertical digital keystone by using the buttons on the keypad.

Press the upper **Keystone** button to reduce the upper part of the image, and press the lower **Keystone** button to reduce the lower part.

You can also adjust the horizontal keystone via the menus. See page 30.

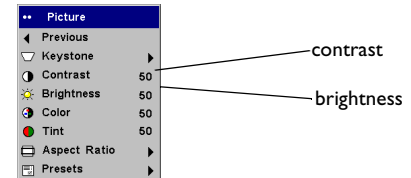
adjust keystone



Adjust the Contrast or Brightness in the Picture menu.

See page 29 for help with the menus.

adjust Contrast or Brightness



# Connecting a video device

## Standard video connections

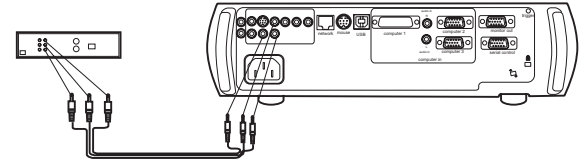
Plug the audio/video (A/V) cable's yellow connector into the video-out connector on the video device. Plug the other yellow connector into the yellow **Video 2** connector on the projector.

Plug a white connector into the left audio out connector on the video device and plug a red connector into the right audio out connector on the video device. Plug the remaining white connector into the left **audio in** connector on the projector (to the right of the yellow **Video 2** connector), and plug the red connector into the right **audio in** connector on the projector.

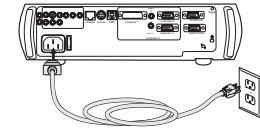
Connect the black power cable to the connector on the back of the projector and to your electrical outlet.

**NOTE:** Always use the power cable that shipped with the projector.

connect A/V cable



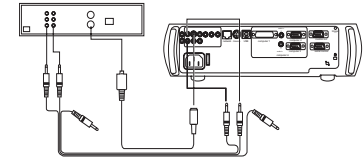
connect power cable



## Optional video connections

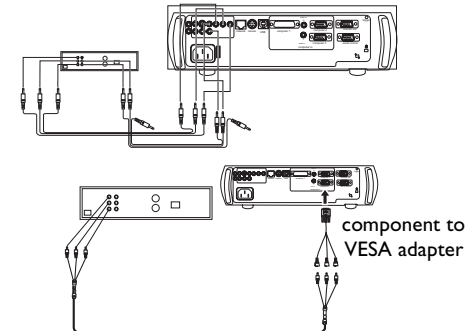
If the video device uses a round, four-prong S-video connector, plug an S-video cable (sold separately) into the S-video connector on the video device and into the **Video 1** connector on the projector. Use the A/V cable's audio connectors as described directly above (the yellow connectors on the A/V cable are not used).

connect S-video and video cables



If the video device uses component cable connectors (sold separately), plug the cable's green connectors into the green component-out connector on the video device and into the green component connector (labeled "**Y**") on the projector. Plug the component cable's blue connectors into the blue component-out connector on the video device and into the blue component connector (labeled "**Pb**") on the projector. Plug the component cable's red connectors into the red component-out connector on the video device and into the red component connector (labeled "**Pr**") on the projector. If you are using RGB input, plug the additional connector into the Video 2/Synch connector and turn on the RGB Video option in the Sources menu. See page 33. To connect a progressive scan EdTV or HD component source, use the Component to VESA adapter to connect the source.

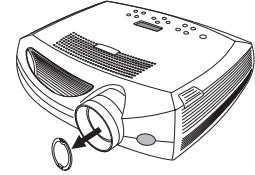
connect component cables and video cables



# Displaying a video image

Remove the lens cap.

remove lens cap

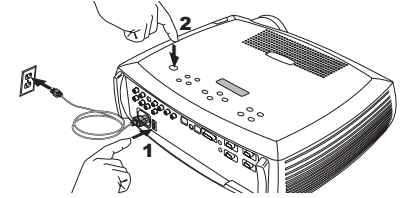


Press the power switch to position "1" on the back of the projector, then press the **Power** button on the top of the projector.

press Power switch



press Power button

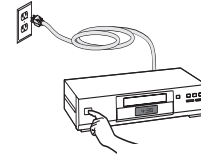


The LED flashes green and the fans start to run. When the lamp comes on, the startup screen is displayed and the LED is steady green. It can take a minute for the image to achieve full brightness.

**? No startup screen?** Get help on page 16.

Plug in and turn on the video device.

turn on video device

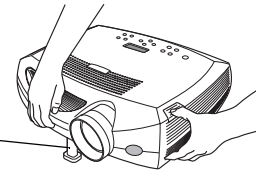


The video device's image should appear on the projection screen. If it doesn't, press the **Video** button on the keypad.

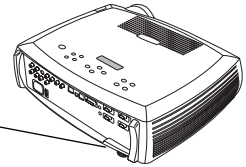
Adjust the height of the projector by pressing the release button to extend the elevator foot. Rotate the leveling foot, if necessary.

adjust height

elevator foot

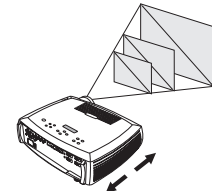


rotate leveling foot



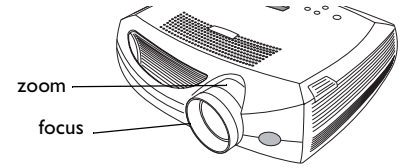
Position the projector the desired distance from the screen at a 90 degree angle to the screen. See page 42 for a table listing screen sizes and distances to the screen.

adjust distance



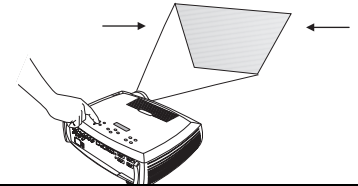
Adjust the zoom or focus rings by rotating them until the desired image size and focus are produced.

adjust zoom and focus



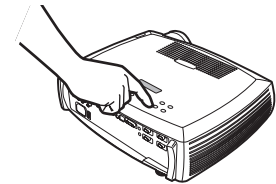
If the image is not square, adjust the vertical keystone using the buttons on the keypad. Press the upper **Keystone** button to reduce the upper part of the image, and press the lower **Keystone** button to reduce the lower part. You can also adjust the horizontal keystone via the menus. See page 30.

adjust keystone



Adjust the volume on the keypad or remote.

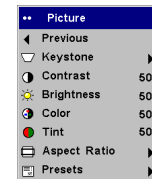
adjust volume



Adjust the **Contrast**, **Brightness**, **Color**, or **Tint** in the Picture menu.

See page 29 for help with the menus.

adjust Picture menu





## Shutting down the projector

The projector automatically blanks the screen after no active source is detected for 30 minutes. This blank screen helps preserve the life of the projector. The image returns when an active source is detected or a remote or keypad button is pressed.

### Screen Save

You can make the blank screen appear after five minutes by turning on Screen Save in the **Settings>System** menu. See page 34.

### Power Save

The projector also has a Power Save feature that automatically turns the lamp off after no signals are detected for 5 minutes. After 3 additional minutes with no signal, the projector powers down. If an active signal is received before the projector powers down, the image is displayed. You must press the Power button to display an image after 30 minutes have passed. When Power Save is enabled, Screen Save is disabled. See page 34.

### Turning off the projector

To turn off the projector, press the **power** button and verify that you want to turn the projector off by pressing the power button again within 3 seconds. You can cancel the shutdown by not pressing the **power** button a second time. The lamp turns off and the LED blinks green for 1 minute while the fans continue to run to cool the lamp. When the lamp has cooled, the LED lights green and the fans stop. Press the power switch on the back of the projector and unplug the power cable to completely power off the projector.

## Troubleshooting your setup

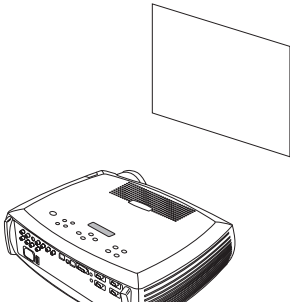
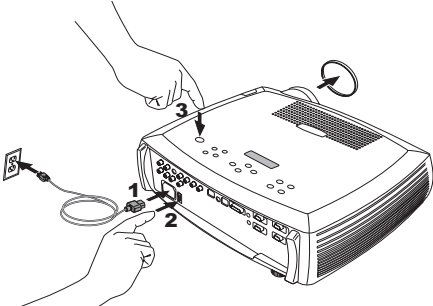
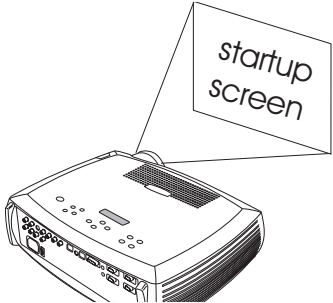
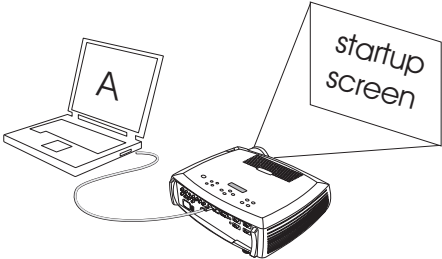

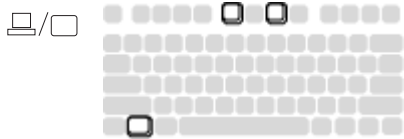
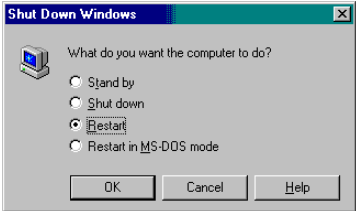
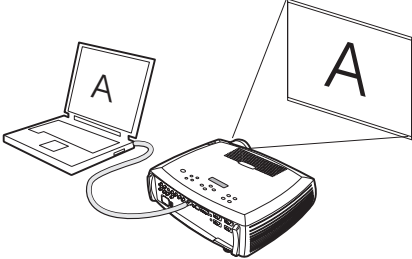
If your image appears correctly on the screen, skip to the next section (page 25). If it does not, troubleshoot the setup. The Interactive Display and LED on top of the projector indicate the state of the projector and can help you troubleshoot.

**Table 1: LED behavior and meaning**

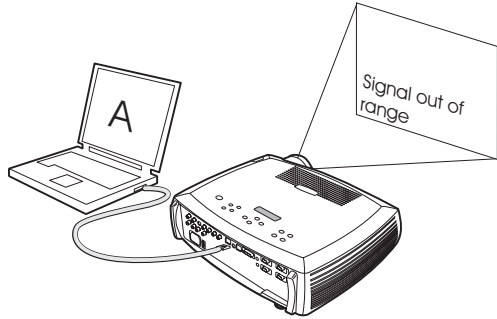
LED color/behavior	Meaning
solid green	The projector is plugged in and the power switch is in the On position, or the projector has been powered on and the software has initialized. The projector has been turned off and the fans have stopped.
blinking green	The power button has been pressed and the software is initializing, or the projector is powering down and the fans are running to cool the lamp.
blinking red see page 42 for more information	A fan or lamp failure has occurred. Make sure the vents aren't blocked (see page 22). Turn off the projector and wait one minute, then turn the projector on again. If the Replace Lamp message appears, replace the lamp and reset the lamp timer. Contact Technical Support if the problem persists.
solid red	An unidentifiable error: please contact Technical Support.

The following tables show common problems. In some cases, more than one possible solution is provided. Try the solutions in the order they are presented. When the problem is solved, you can skip the additional solutions.

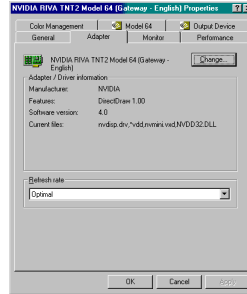
## Source Troubleshooting

Problem	Solution	Result
<p data-bbox="48 187 258 211"><b>No startup screen</b></p> 	<p data-bbox="661 152 1117 207"><b>Plug power cable in, press power switch, press power button. Remove lens cap.</b></p> 	<p data-bbox="1183 187 1355 211"><b>Correct image</b></p> 
<p data-bbox="48 543 371 567"><b>Only startup screen appears</b></p> 	<p data-bbox="661 577 979 632"><b>Press the Computer button</b> </p> <p data-bbox="661 615 1012 639"><b>Activate laptop's external port</b></p>  <p data-bbox="656 816 770 871"><b>or restart laptop</b></p> 	<p data-bbox="1183 543 1498 567"><b>Computer image projected</b></p> 

**No computer image, just the words “Signal out of range”**

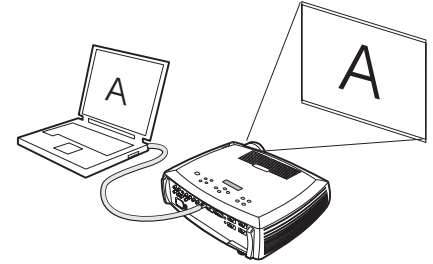


**Adjust computer refresh rate in Control Panel>Display>Settings>Advanced>Adapter (location varies by operating system)**

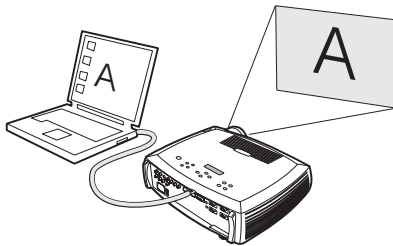


**You may also need to set a different resolution on your computer, as shown in the problem, “Image fuzzy or cropped”**

**Computer image projected**

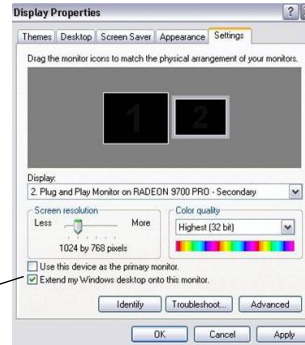


**Only my laptop’s background appears, not the Desktop icons**

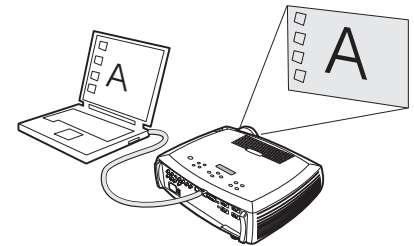


**Disable “Extend my Windows Desktop” in Control Panel>Display>Settings>Display 2 (location varies by operating system)**

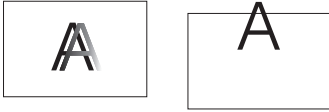
**Uncheck this option, then click Apply**



**Background and Desktop projected**

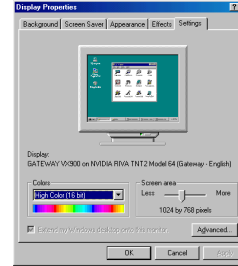


**Image fuzzy or cropped**



**Set your computer's display resolution to the native resolution of the projector (Start>Settings>Control Panel>Display>Settings tab, select 1024x768)**

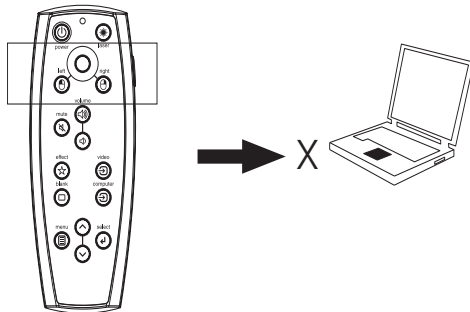
**For a laptop, disable laptop monitor or turn-on dual-display mode**



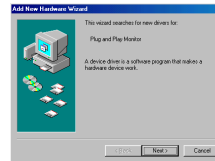
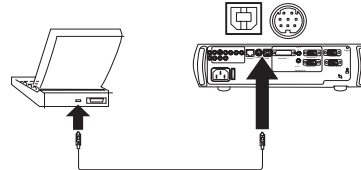
**Image clear and not cropped**



**Remote control not controlling my computer's mouse**

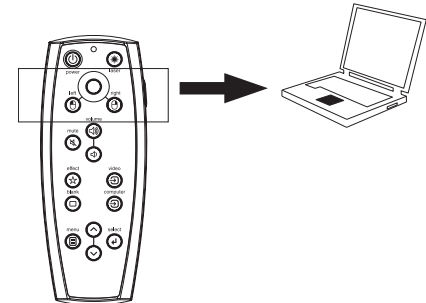


**Connect USB cable (page 7) then load USB drivers, if needed (page 10). Or, connect PS/2 cable and reboot your computer.**



**Remote controls computer cursor. Note that the mouse is not functional in zoom mode (see page 35)**

**See page 25 for information on the remote**



## Projector troubleshooting

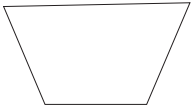
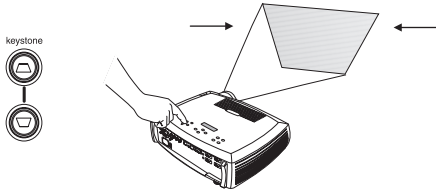


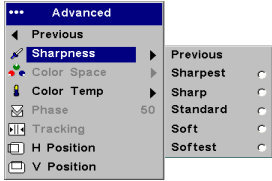


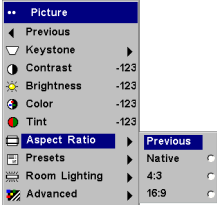

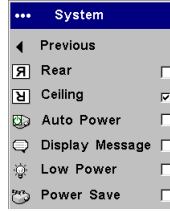
Problem	Solution	Result
<p data-bbox="48 156 251 181">Image not square</p> 	<p data-bbox="661 156 1161 181">Adjust keystone on keypad or Picture menu</p> 	<p data-bbox="1185 156 1345 181">Square image</p> 
<p data-bbox="48 420 239 445">Image not sharp</p> 	<p data-bbox="661 420 1126 472">Adjust the focus lens or Sharpness in the Picture&gt;Advanced menu</p> 	<p data-bbox="1185 420 1355 445">Correct image</p> 
<p data-bbox="48 714 392 739">Image does not fit 16:9 screen</p> 	<p data-bbox="661 714 1005 766">Change aspect ratio to 16:9 in Picture&gt;Aspect ratio menu</p> 	<p data-bbox="1185 714 1355 739">Correct image</p> 

Image upside down



Turn off Ceiling in Settings>System menu



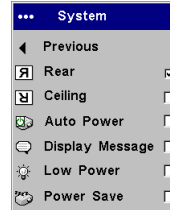
Correct image



Image reversed left to right



Turn off Rear in Settings>System menu



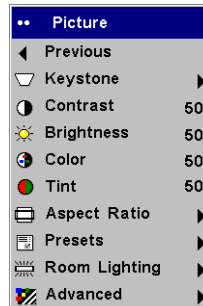
Correct image



Projected colors don't match source



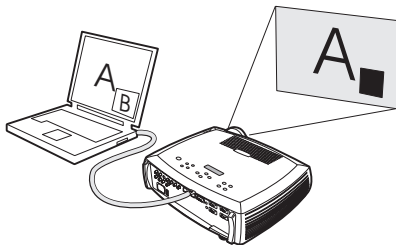
Adjust color, tint, color temperature, brightness, contrast in the menus



Correct image

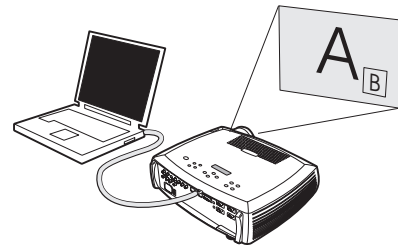


The video embedded in my PowerPoint presentation does not play on the screen

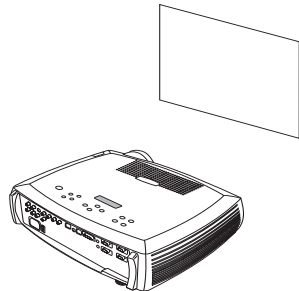
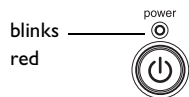


Turn off the internal LCD display on your laptop

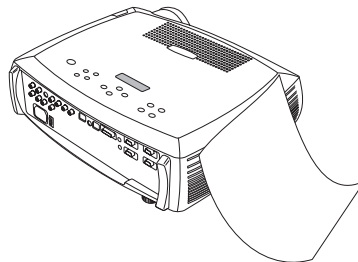
Embedded video plays correctly



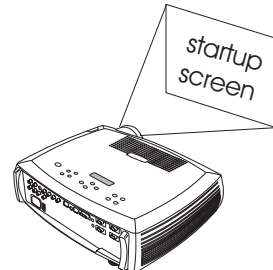
Lamp won't turn on, LED blinking red (page 16)



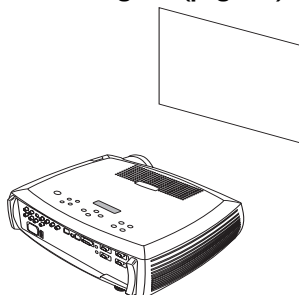
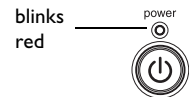
Make sure vents aren't blocked; allow projector to cool for one minute



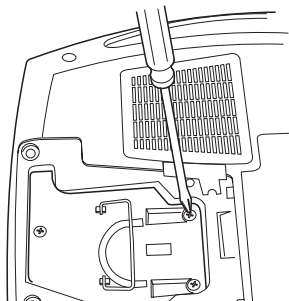
Unplug projector; wait one minute; plug in projector and turn it on: lamp lights



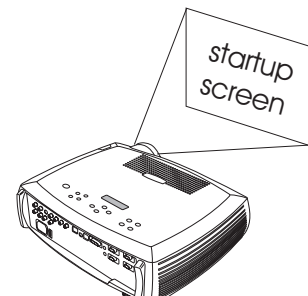
Lamp won't turn on, LED blinking red (page 16)



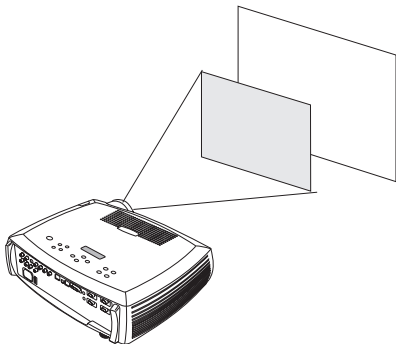
Lamp must be replaced (page 38)



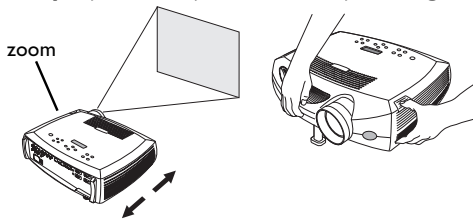
Lamp turns on



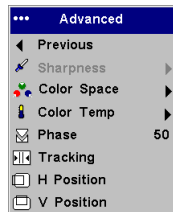
### Image not centered on screen



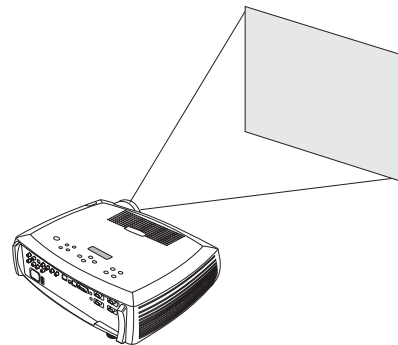
### Move projector, adjust zoom, adjust height



### Adjust horizontal or vertical position in Picture>Advanced menu



### Correct image



### Still having problems?

If you need assistance, please visit our website or call us. See the inside of the back cover for a list of all relevant web addresses.

This product is backed by a limited two-year warranty. An extended warranty plan may be purchased from your dealer. When sending the projector in for repair, we recommend shipping the unit in its original packing material, or having a professional packaging company pack the unit. An optional ATA shipping case is available for purchase that provides adequate protection for shipping. Please insure your shipment for its full value.



# Using the keypad buttons

Most buttons are described in detail in other sections, but here is an overview of their functions:

**power**—turns the projector on (page 9) and off (page 14).

**menu**—opens the on-screen menus (page 29).

**select**—confirms choices made in the menus (page 29).

**up/down arrows**—navigates to and adjusts settings in the menus (page 29).

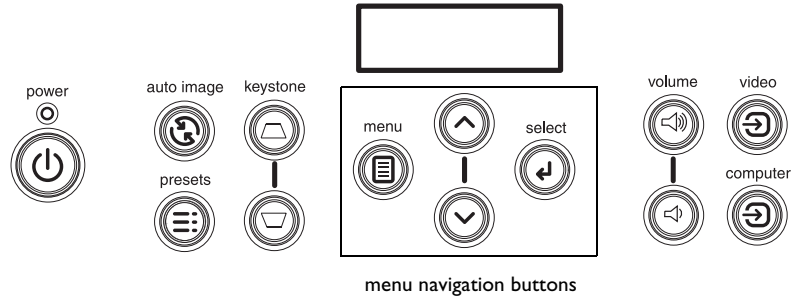
**auto image**—resets the projector to the source.

**presets**—cycles through the available preset settings (page 31).

**keystone**—vertical keystone adjusts the squareness of the image (page 12). You can also adjust the horizontal keystone via the menus. See page 30.

**volume**—adjusts sound (page 26).

**video and computer**—changes the active source.



## Using the remote control

The remote uses two (2) provided AAA batteries. They are easily installed by sliding the cover off the remote's back, aligning the + and - ends of the batteries, sliding them into place, and then replacing the cover.

To operate, point the remote at the projection screen or at the projector (not at the computer). The range of optimum operation is about 30 feet (9.14m).

To use the laser pointer, press and hold the **Laser** button. The laser turns off when the button is released, or times out after two (2) minutes of continuous operation.

**WARNING:** Do not look into the laser beam emitted from the top of the remote control.

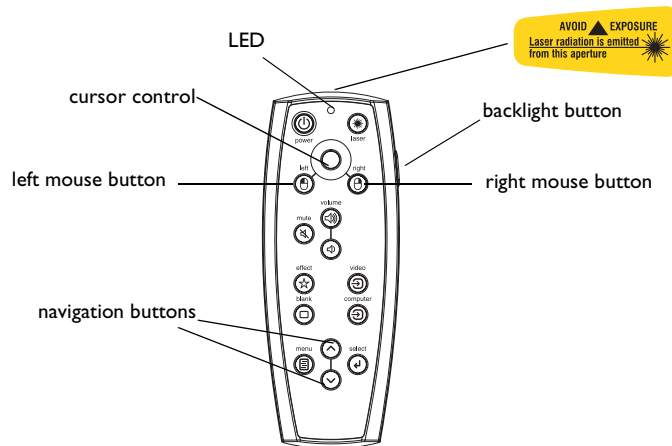
Left and right remote mouse buttons are used to mimic the actions of the left/right mouse buttons on your computer. Mouse cursor movement is managed via the remote's Cursor control. Connect a USB or PS/2 cable to the projector and the computer to use these buttons and control your computer's mouse. When you do this for the first time, the Add New Hardware wizard may appear. See page 10 for details on loading the correct USB drivers.

Press the remote's **Menu** button to open the projector's menu system. Use the arrow buttons to navigate, and the Select button to select features and adjust values in the menus. See page 29 for more info on the menus.

The remote also has a power button to turn the projector on and off (see page 16 for shutdown info), volume and mute buttons to control the sound, a backlight button to light the remote's buttons in the dark, and video and computer buttons to switch between sources.

Two presentation-specific features are also provided. Use the blank button to display a blank screen instead of the current slide (you can choose which color is displayed, see page 34); use the effect button to invoke a user-definable action, such as freeze or zoom (see page 35 to learn to program this button).

If you are displaying presentations in Microsoft® PowerPoint®, you can use the remote's mouse buttons to navigate through your presentation while in Slide Show mode. To configure PowerPoint for this, choose Options from the PowerPoint Tools menu, click the View Tab, de-select the "Popup Menu on Right Mouse Click" option in the Slide Show section, then click OK. Then, when you're in PowerPoint's Slide Show mode, a left click advances to the next slide and a right click returns to the previous slide (other PowerPoint modes are not affected).



### Troubleshooting the remote

- Make sure the batteries are installed in the proper orientation and are not dead. The LED at the top of the remote lights when any button is pressed when the battery power is adequate.
- Make sure you're pointing the remote at the projector, not the computer, and are within the remote range of 30 feet (9.14m).
- If you are trying to control your computer's mouse, make sure a mouse cable is connected. If using a USB cable, make sure the correct drivers are installed.

# Using the audio

To play sound from the projector, connect your source to the Audio In connector on the projector.

To adjust the volume, use the buttons on the keypad or remote.

To adjust the bass, treble, balance, or loudness, use the Audio menu (see page 33).

To mute the sound, press the **Mute** button.

## Troubleshooting audio

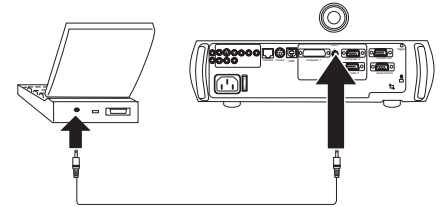
If there is no sound, check the following:

- Make sure the audio cable is connected.
- Make sure mute isn't active.
- Make sure the volume is turned up enough. Press the volume button on the keypad or remote.
- Make sure you are connected to the corresponding **audio in** for your source. **Computer 1** and **2** share a single audio input, as do **Video 2** and **3**.
- Adjust the audio source.
- If playing a video, make sure the playback has not been paused.

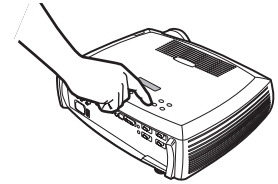
## Connecting external speakers

The projector can be attached to external speakers that have their own power source by plugging speaker cables into the projector's left and right **Audio Out** connectors.

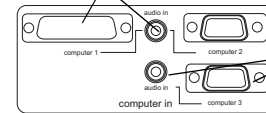
connect audio cable



adjust volume

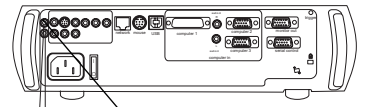
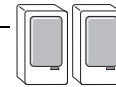


computer 1 and corresponding audio



computer 3 and corresponding audio

external speakers



audio out

speaker cable

## Optimizing computer images

After your computer is connected properly and the computer's image is on the screen, you can optimize the image using the onscreen menus. For general information on using the menus, see page 29.

- Adjust the Keystone, Contrast, or Brightness in the Picture menu.
- Change the Aspect Ratio. Aspect Ratio is the ratio of the image width to image height. TV screens are usually 1.33:1, also known as 4:3. HDTV and most DVDs are 1.78:1, or 16:9. Choose the option that best fits your input source. See page 30 for details.
- Adjust the Color Temperature in the Advanced menu.
- Adjust the Phase, Tracking, or Horizontal or Vertical position in the Advanced menu.
- Once you have optimized the image for a particular source, you can save the settings using Presets. This allows you to quickly recall these settings later. See page 31.
- Adjust the Room Lighting. Select Dark if you are in a dark room, Light if in a bright room (page 31).

## Presentation features

Several features are provided to make giving presentation easier. The following is an overview, details are found in the menu section on page 29.

- The remote's **Effect** button allows you to assign various features to the key. The default effect is Zoom. You can select from Blank, Mute, Aspect Ratio, Source, Auto Image, Freeze, Zoom, About, PiP, Mask, and Screen Trigger. See page 35 for details.
- The Freeze effect allows you to freeze the displayed image. This is useful if you want to make changes on your computer without your audience seeing them.
- The **Blank** button on the remote allows you to display a blank screen instead of the active source. See page 34.
- The PiP effect lets you show a video source in a smaller window on top of the computer image. See page 35.
- The Startup Logo menu option lets you change the default startup screen to a black, white, or blue screen. See page 34.
- Two menu options, Power Save and Screen Save, are provided to automatically shut down the projector after several minutes of inactivity or display a blank screen. This helps preserve lamp life. See page 33 and page 34.
- A Low Power menu option is also available on the C420 only to help lower the projector's fan sound volume. See page 33.

## Optimizing video images

After the video device is connected properly and the image is on the screen, you can optimize the image using the onscreen menus. For general information on using the menus, see page 29.

- Adjust the Keystone, Contrast, Brightness, Color, or Tint in the Picture menu. See page 30.
- Change the Aspect ratio. Aspect ratio is the ratio of the image width to image height. TV screens are usually 1.33:1, also known as 4:3. HDTV and most DVDs are 1.78:1, or 16:9. Choose the option that best fits your input source. See page 30.
- Select a Sharpness setting. See page 32.
- Adjust the Color Temperature. Select a listed value, or select User and individually adjust the intensity of the red, green, and blue color. See page 32.
- Adjust the Room Lighting. Select Dark if you are in a dark room, Light if in a bright room (page 31).

## Customizing the projector

You can customize the projector for your specific setup and needs. See page 33 to page 37 for details on these features.

- For rear projection, turn Rear mode on in the **Settings>System** menu.
- For ceiling mounted projection, turn Ceiling mode on in the **Settings>System** menu.
- Specify which source the projector checks first for active video during power-up.
- Specify the function of the Effect Key on the remote.
- Turn the projector's display messages on and off.
- Turn on power saving features.
- Specify blank screen colors and startup logos.
- Specify the menu language.
- Manage your projector via ProjectorNet software. See page 8 for more information.
- Project wirelessly with LiteShow wireless adapter. See page 6.
- Control your projector using RS232 commands. See page 8.
- Use the screen trigger to control your projection screen. See page 6.
- Customize the projector for your specific installation using optional long or short throw lenses. See page 41 for ordering information.

# Using the menus

To open the menus, press the menu button on the keypad or remote. (The menus automatically close after 60 seconds if no buttons are pressed.) The Main menu appears. Use the arrow buttons to move up and down to highlight the desired submenu, then press the **Select** button.

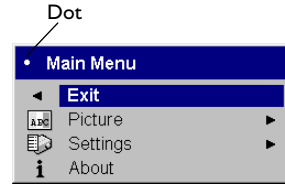
To change a menu setting, highlight it, press **Select**, then use the up and down arrow buttons to adjust the value, select an option using radio buttons, or turn the feature on or off using check boxes. Press **Select** to confirm your changes. Use the arrows to navigate to another setting. When your adjustments are complete, navigate to Exit, then press **Select** to go to the previous menu; press the **Menu** button at any time to close the menus.

Dots appear before the menu name. The number of dots indicate the menu's level, ranging from one (the Main menu) to four (the most nested menus).

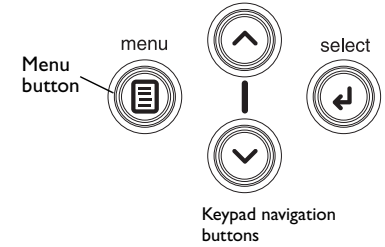
The menus are grouped by usage:

- The Picture menu provides image adjustments.
- The Settings menu provides set-up type adjustments that are not changed often.
- The About menu provides a read-only display of information about the projector and source.

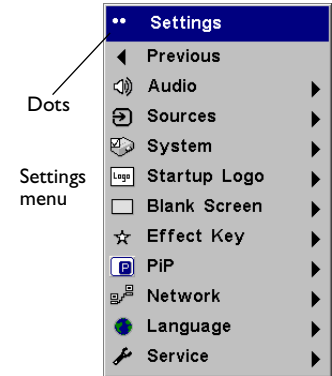
Certain menu items may be grayed out until a particular source is connected. For example, Sharpness is only available for video sources and will be hidden when a computer source is active. Other menu items may be grayed out when they are not available. For example, Brightness is grayed out until an image is active.



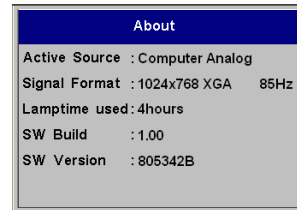
Main menu



Picture menu



Settings menu



About menu

## Picture menu

To adjust the following six settings, highlight the setting, press **Select**, use the up and down arrows to adjust the values, then press select to confirm the changes.

**Vertical Keystone:** adjusts the image vertically and makes a squarer image. You can also adjust vertical keystone from the keypad.

**Horizontal Keystone:** adjusts the image horizontally and makes a squarer image.

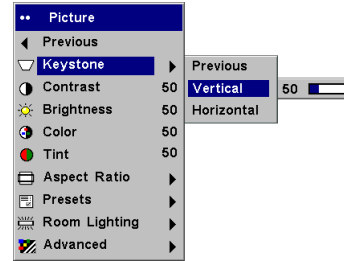
**Contrast:** controls the degree of difference between the lightest and darkest parts of the picture and changes the amount of black and white in the image.

**Brightness:** changes the intensity of the image.

**Color:** (video sources only) adjusts a video image from black and white to fully saturated color.

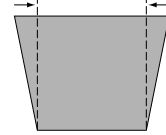
**Tint:** (NTSC video sources only) adjusts the red-green color balance in the image.

**Aspect Ratio:** Aspect ratio is the ratio of the image width to image height. TV screens are usually 1.33:1, also known as 4:3. HDTV and most DVDs are 1.78:1, or 16:9. The default is 4:3, which displays the input resized up or down to fill the display area.

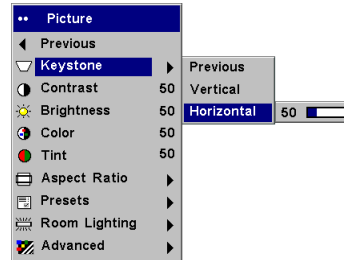
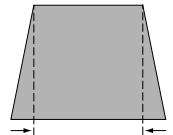


Vertical Keystone

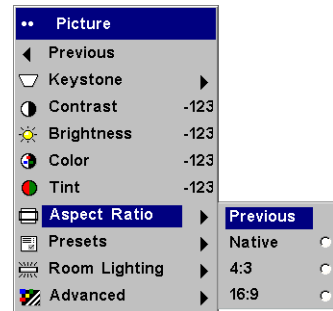
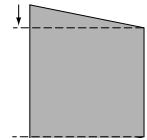
increasing keystone



decreasing keystone



Horizontal Keystone

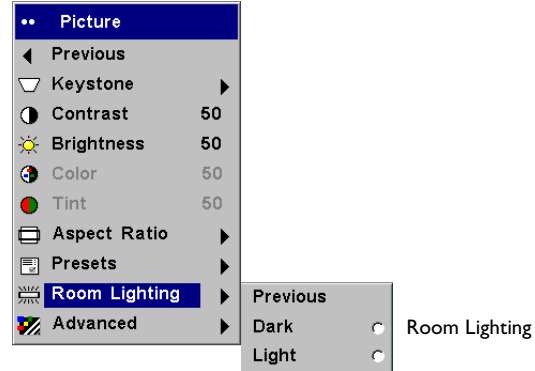
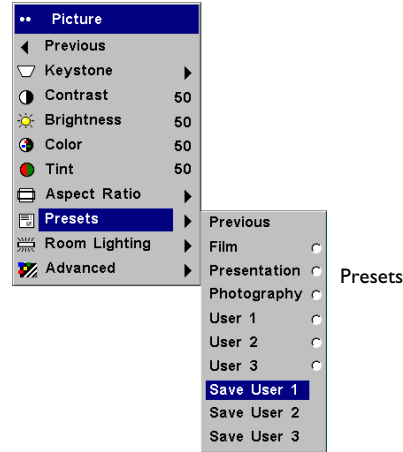


Aspect Ratio

**Presets:** The provided Presets optimize the projector for displaying computer presentations, photographs, film images, and video images. (Film input is material originally captured on a film camera, like a movie; video input is material originally captured on a video camera, like a TV show or sporting event.) You can use the preset as a starting point, then further customize the settings for each source. The settings you customize are saved in the preset for each source. To restore the factory default settings, choose Factory Reset in the **Settings>Service** menu.

There are also three user-definable presets. To set a preset for the current source, adjust the image, then choose Save User 1, 2, or 3. You can recall these settings in the future by selecting the appropriate user presets.

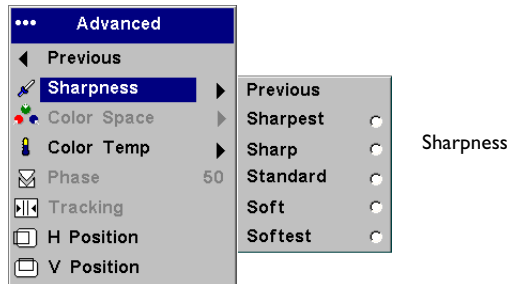
**Room Lighting:** This features optimizes the projector for your room's lighting conditions. Select Dark if you are in a dark room, Light if in a bright room. Choosing Light maximizes the light output from the projector.



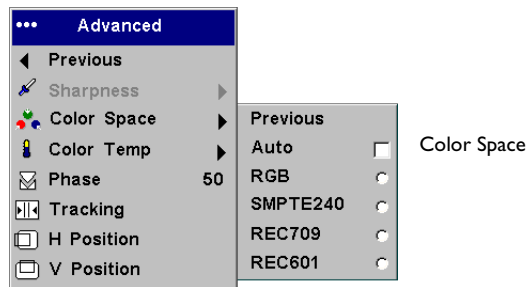


## Advanced settings

**Sharpness:** (video sources only) changes the clarity of the edges of a video image. Select a sharpness setting.



**Color Space:** This option applies to computer and component video sources. It allows you to select a color space that has been specifically tuned for the video input. When Auto is selected, the projector automatically determines the standard. To choose a different setting, turn off Auto, then choose RGB for computer sources, choose either SMPTE240, REC709 or REC601 for component video sources.



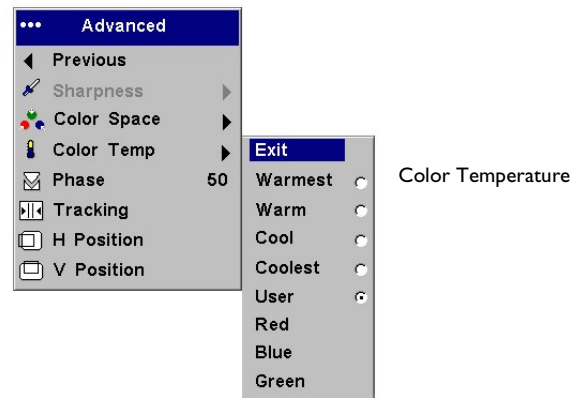
**Color Temperature:** changes the intensity of the colors. Select a listed value, or select User and individually adjust the intensity of the red, green, and blue colors.

The following 4 options are for computer sources only.

**Phase:** adjusts the horizontal phase of a computer source.

**Tracking:** adjusts the vertical scan of a computer source.

**Horizontal/Vertical Position:** adjusts the position of a computer source.



## Settings menu

**Audio:** allows adjustments to the volume, bass, treble and balance. Also allows you to turn on and off Loudness (which boosts the higher and lower frequencies), the Internal speakers, and projector startup Chime.

**Sources:** allows you to assign a particular input to a specific source key when using the optional Integrator remote. Also allows selection of a default Startup Source and enables or disables Autosource and RGB.

**Sources>Startup Source:** this determines which source the projector checks first for active video during power-up.

**Sources>Autosource:** When Autosource is not checked, the projector defaults to the source selected in Startup Source. If no source is found, a blank screen displays. When Autosource is checked, Startup Source determines which source the projector defaults to at power-up. If no signal is present, the projector checks the sources in order until a source is found or until power down.

**Sources>RGB Video:** check this box if you are using a DVD player with RGB output.

**System>Rear:** reverses the image so you can project from behind a translucent screen.

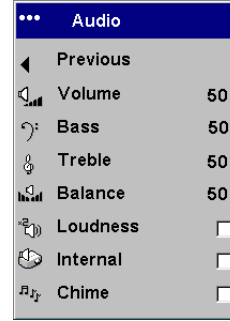
**Ceiling:** turns the image upside down for ceiling-mounted projection.

**Auto Power:** When Auto Power is checked, the projector automatically goes into the startup state after the projector is powered on. This allows control of ceiling mounted projectors with a wall power switch.

**Display Messages:** displays status messages (such as “Searching” or “Mute”) in the lower-left corner of the screen.

**Low Power:** (C420 only) toggles between on and off. Turn it on to lower the light output of the lamp. This also lowers the fan speed, making the projector quieter.

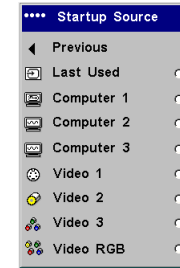
**Power Save:** automatically turns the lamp off after no signals are detected for 5 minutes. After 3 additional minutes with no signal, the projector powers down. If an active signal is received before the projector powers down, the image will be displayed.



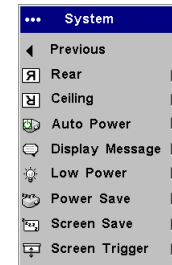
Audio



Sources



Startup Source



System menu

**Screen Save:** automatically blanks the screen after no signals are detected for five minutes. The image returns when an active source is detected or a remote or keypad button is pressed. Screen Save is disabled when Power Save is enabled.

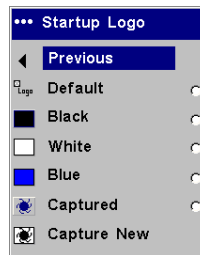
**Screen Trigger:** this enables the Screen Trigger connection on the connector panel. See page 6 for details.

**Startup Logo:** allows you to display a blank Black, White, or Blue screen instead of the default screen at startup and when no source is detected. It also allows you to capture and display a custom startup screen.

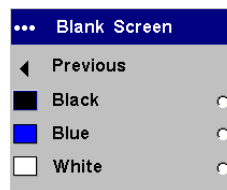
To capture a custom logo, display the image you want to capture on your computer, highlight Capture New, then press **Select** twice. While the capture is underway, the LED on the keypad turns orange. When ready, the projector confirms the capture and the LED changes to green.

The next time you start the projector, the custom logo you captured displays.

**Blank Screen:** determines what color is displayed when you press the **Blank** button on the remote.



Startup Logo



Blank Screen

**Effect Key:** allows you to assign a different function to the **Effect** button on the remote to quickly and easily use the effect. Only one effect can be enabled at a time. Highlight an effect and press **Select** to choose a different one.

**Blank:** shows an empty screen.

**Mute:** turns off all sound.

**Aspect Ratio:** sets the ratio of the image width to image height.

**Source:** cycles through the available sources.

**Auto Image:** causes computer sources to be reacquired.

**Freeze:** pauses the projected image.

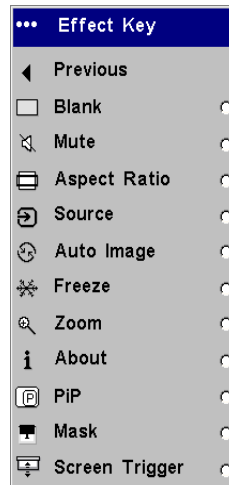
**Zoom:** Is the default effect. It lets you magnify a part of the screen. To use the Zoom effect, press **Effect**, then press the remote's left mouse to zoom the image, press the right mouse button to decrease the magnification. You can use the cursor control to pan the image, displaying different parts of it (only if the image is magnified). To return to the original size and cancel Zoom, press the **Effect** button a second time.

**About:** displays the About menu.

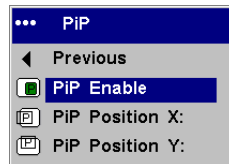
**PiP:** (Picture in Picture) allows you to overlay a smaller window showing the video source on top of the larger computer source window. You must have both a computer and video source connected to use PiP. You can't show a computer image in the smaller PiP window, only a video image. You can select a small, medium, or large window. You can also move the PiP window on the screen using the PiP Position X and Y options in the menu. Press the up and down arrows to change the position.

**Mask:** allows you to cover part of the image with a black curtain. Press the up and down arrows to raise or lower the curtain on the image.

**Screen Trigger:** this enables the Screen Trigger connection on the connector panel. See page 6 for details.



Effect Key



Picture in Picture

**Network:** The projector has an RJ45 Ethernet connector that supports network connections and TCP/IP protocols. This will allow for the control and management of the projector over a corporate network. The following fields are accessible when DHCP is not checked and available for manual entry of data.

**IP Address:** Identifies the projector on the network.

**Subnet mask:** Separates the network address part of the IP address.

**Default gateway:** The IP address of the local router.

**DHCP:** Select this to automatically obtain an IP address, Subnet mask, and Default gateway.

**Network Info:** Provides information on the network configuration.

The **Network Info** menu is informational and cannot be edited. It displays the current IP Address, Subnet Mask, Default Gateway, and the projector's MAC Address.

**Language:** allows you to select a language for the onscreen display of menus and messages.

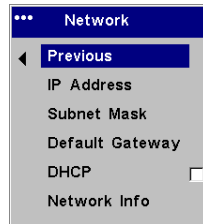
**Service:** to use these features, highlight them and press **Select**.

**Factory Reset:** restores all settings (except Lamp Hours and Network settings) to their default after displaying a confirmation dialog box.

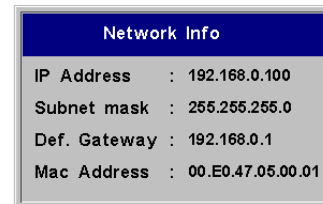
**Reset Lamp:** resets the lamp hours counter in the About menu to zero. Do this only after changing the lamp. It displays a confirmation dialog box.

**Service Info:** provides information about the projector's software version and the active source.

**Service Code:** only used by authorized service personnel.



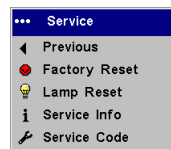
Network



Network Info



Language



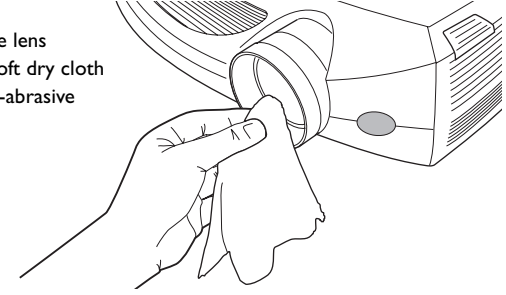
Service menu

# Maintenance

## Cleaning the lens

- 1 Apply a non-abrasive camera lens cleaner to a soft, dry cloth.  
  
Avoid using an excessive amount of cleaner, and don't apply the cleaner directly to the lens. Abrasive cleaners, solvents or other harsh chemicals might scratch the lens.
- 2 Lightly wipe the cleaning cloth over the lens in a circular motion. If you don't intend to use the projector immediately, replace the lens cap.

clean the lens  
with a soft dry cloth  
and non-abrasive  
cleaner

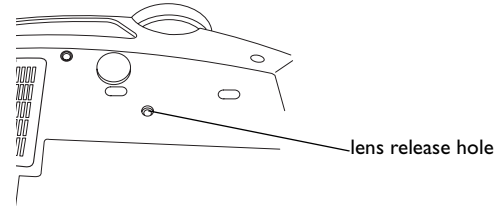
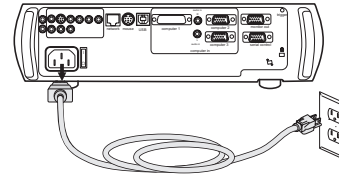


## Changing the lens

Optional long throw and short throw lenses are available. See “Optional Accessories” on page 41 for ordering information.

- 1 Turn off the projector and unplug the power cable.
- 2 Set the projector upright with the lens facing upward, place a screwdriver or other narrow object in the release hole on the bottom of the projector, then twist the lens counterclockwise to remove it.
- 3 To install the new lens, align the red dot (near the base of the lens) with the top of the projector and turn clockwise until you feel the lens click into place.

turn off and unplug  
the projector

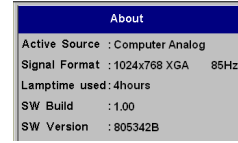


## Replacing the projection lamp

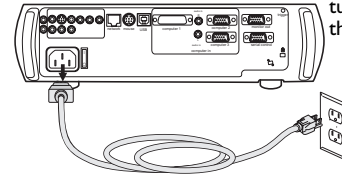
The lamp hour timer in the About menu counts the number of hours the lamp has been in use. When the specified end of the lamp's life is reached, the message "Replace lamp" briefly appears on the screen at each startup and in the Interactive Display. You can order new lamp modules from your dealer. See "Accessories" on page 41 for information.

- 1 Turn off the projector and unplug the power cable.
- 2 Wait 60 minutes to allow the projector to cool thoroughly.
- 3 Turn the projector upside down and remove the lamp door by removing the two screws and sliding the lamp door tabs out of the two tab bays.

- 4 Loosen the three captive screws on the lamp module.

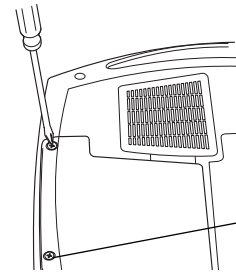
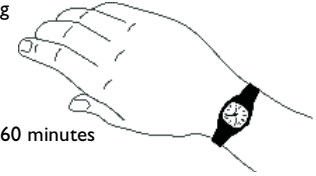


About menu

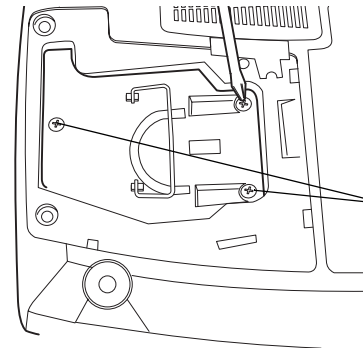


turn off and unplug  
the projector

wait 60 minutes



remove the screws on lamp door



loosen the screws on lamp module

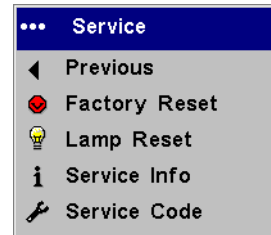
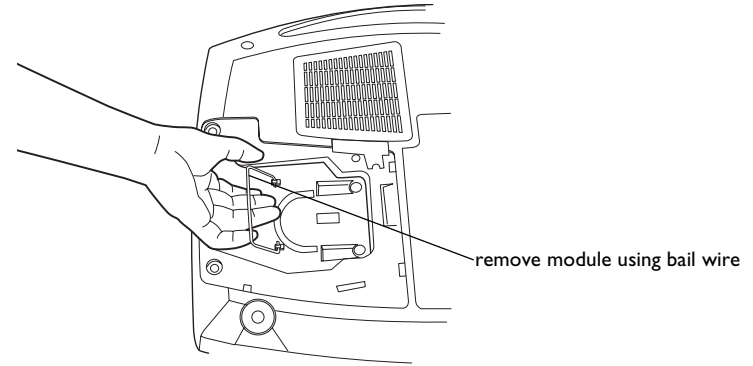
## WARNINGS:

- To avoid burns, allow the projector to cool for at least 60 minutes before you replace the lamp.
- Do not drop the lamp module. The glass may shatter and cause injury.
- Do not touch the glass lamp screen. Fingerprints can obscure projection sharpness.
- Be extremely careful when removing the lamp housing. In the unlikely event that the lamp ruptures, small glass fragments may be generated. The lamp module is designed to contain most of these fragments, but use caution when removing it.

- 5 Carefully remove the lamp module by grasping and lifting the metal bail wire. Dispose of the lamp in an environmentally proper manner.
- 6 Install the new lamp module, making sure that it is properly seated.
- 7 Tighten the three screws.
- 8 Replace the lamp door by inserting the tabs into the tab bays and tightening the two screws.
- 9 Plug in the power cable, press the power switch then press the **Power** button to turn the projector back on.
- 10 Reset the lamp hour timer.

## Resetting the lamp timer

After replacing the lamp, reset the lamp timer. Navigate to the **Settings>Service** menu and select **Lamp Reset** to reset the lamp timer.



reset lamp time in Service menu

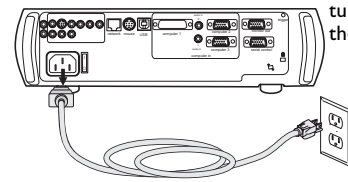


## Cleaning the dust filter

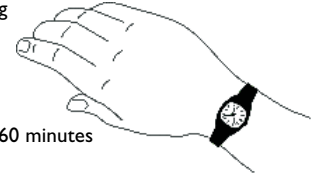
- 1 Turn off the projector and unplug the power cable.
- 2 Wait 60 minutes to allow the projector to cool thoroughly.

**WARNING:** To avoid burns, allow the projector to cool for at least 60 minutes before you clean or replace the dust filter.

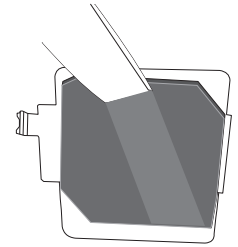
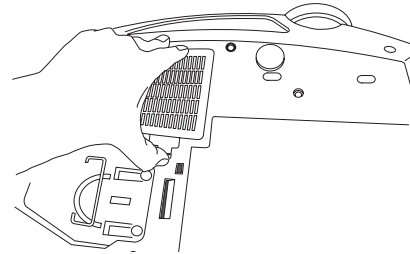
- 3 Turn the projector upside down and remove the lamp door. See page 38.
- 4 Press the tab on the dust filter and lift it off.
- 5 Clean the filter using a vacuum set on low power.
- 6 Replace the dust filter and the lamp door.



turn off and unplug  
the projector

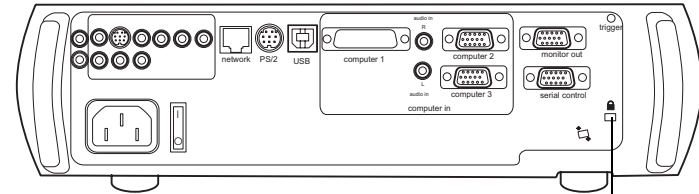


wait 60 minutes



## Using the security lock

The projector has a security lock for use with a cable lock system. See "Accessories" on page 41 for ordering information. Refer to the information that came with the lock for instructions on how to use it.



security lock

# Appendix

## Accessories

### Standard Accessories (ship with the projector)

	Part Number
Shipping Box (with packaging)	111-0033-xx
Protective Cover	110-0710-xx
Computer Cable 6 ft (1.8 m)	516-0062-xx
Audio/Video Cable 6 ft (1.8 m)	516-0051-xx
Audio Cable 6 ft (1.8 m)	301398B
Component to VESA Adapter	SP-VESA-ADPT
Power Cable*	516-0052-xx
USB Cable	301378A
Conductor Plus Remote	HW-CONDUCTOR+
Projection Lamp Module (included in projector)	SP-LAMP-012
Lens Cap	340-1185-xx
Quick Setup card	009-0657-xx
User's Guide with CD	010-0453-xx
Safety Card	009-0659-xx
Color-coded Cable Ties, 3 set	SP-CABLETIES
SCART Adapter*	301130

\*country-dependent

### Optional Accessories

### Part Number

Shipping Case (ATA approved)	CA-ATA-017
Projector Mount	SP-CEIL-005-B
False Ceiling Plate for Projector Mount	SP-LTMT-PLT
Extension Arm for Projector Mount 26" - 47"	SP-LTMT-EXTP
Short Throw Lens	LENS-020
Long Throw Lens	LENS-021
DVI-D Cable 6 ft (1.8 m)	SP-DVI-D
LiteShow Wireless Connection	LP-LITESHOW
ProjectorNet Software	SW-PN2-1CD
VGA Cable/Line Amp Extension, 50 ft (15m)-Domestic	SP-VGAEXT50-D
VGA Cable/Line Amp Extension, 50 ft (15m)-International	SP-VGAEXT50-I
Audio/Video Cable, 30 ft (9m)	SP-AV30
Projector Cable Lock System	SP-LOCK-B
50" Diagonal Screen (portable)	A650
60" Diagonal Screen (portable)	HW-DLXSCRN
84" Diagonal Wall/Ceiling Mounted Screen	HW-WALLSCR84
Replacement Lamp Module	SP-LAMP-012
MindPath RF PocketPoint Remote	HW-RF-POCKTPNT
IR Presentation Remote Control	HW-PRESENTER
IR Integrator Remote Control	HW-INTEGRATOR

**NOTE:** Use only approved accessories.

## Red LED behavior and projector errors

If the projector is not functioning properly and the red LED is blinking, consult **Table 2** to determine a possible cause. There are two second pauses between the blinking cycles. Visit our website for more details on the red LED error codes. See the inside back cover for contact information.

**Table 2:**

<b>Red LED Behavior</b>	<b>Explanation</b>
One (1) blink	The lamp won't strike after five (5) attempts. Check the lamp and lamp door installations for loose connections.
Two (2) blinks	The lamp counter hours have exceeded lamp life hours. Replace the lamp and reset the lamp hours counter.
Three (3) blinks	The projector has shut down the lamp. Replace the lamp. Contact Technical Support for repair if replacing the lamp does not solve the problem.
Four (4) blinks	The fan has failed. Contact Technical Support for repair.
Five (5) blinks	The projector is overheating. Check for a blocked air vent. Contact Technical Support for repair if clearing the air vents does not solve the problem.

## Projected image size

**Table 3:  
Image sizes for standard lens**

<b>Distance to screen (feet/m)</b>	<b>Minimum Width (feet/m)</b>	<b>Maximum Width (feet/m)</b>
5/1.52	2.08/0.64	2.78/0.85
8/2.44	3.33/1.02	4.44/1.35
12/3.66	5.0/1.52	6.67/2.03
16/4.88	6.67/2.03	8.89/2.71
20/6.1	8.33/2.54	11.11/3.39
30/9.14	12.5/3.81	16.67/5.08
33/10.1	13.75/4.19	18.33/5.59

**Table 4:  
Image sizes for long throw lens**

<b>Distance to screen (feet/m)</b>	<b>Minimum Width (feet/m)</b>	<b>Maximum Width (feet/m)</b>
16/4.88	3.02/0.92	5.33/1.63
20/6.1	3.77/1.15	6.67/2.03
30/9.14	5.66/1.73	10/3.05
40/12.19	7.55/2.3	13.33/4.06
50/15.24	9.43/2.88	16.67/5.08
100/30.48	18.87/5.75	33.33/10.16

**Table 5:**  
**Image sizes for short throw lens (fixed focus)**

<b>Distance to screen (feet/m)</b>	<b>Width (feet/m)</b>
3/0.91	2.5/0.76
5/1.52	4.17/1.27
8/2.44	6.67/2.03
12/3.66	10/3.05
16/4.88	13.33/4.06
20/6.1	16.67/5.08

**NOTE:** Visit our website for an interactive image size calculator.

## **Numerics**

1024x768 resolution 5

## **A**

About 35

Aspect Ratio 35

audio 26

Audio In connector 7, 13

audio volume 15

Auto Image 35

Auto Power 33

## **B**

Blank 35

blinking green 16

blinking red 16

Brightness 12

## **C**

cables

    optional 41

    standard 41

changing the lens 37

cleaning the dust filter 40

cleaning the lens 37

Color 15

colors are incorrect 21

component cable connector 13

computer connections

    optional 7

    required 7

computer image

    optimize 27

    troubleshooting 17

connector panel 6

contacting InFocus 23

Contrast 12, 15

custom logo

    startup screen 34

customer service contact information 23

## **D**

Default gateway 36

DHCP 36

Display Messages 33

displaying

    computer image 9

    PiP 35

    video image 14

Drivers 10

    USB 11

    Windows 98 11

dust filter, cleaning 40

## **E**

Effect Key 35

elevator foot 12

## **F**

first time use

    driver installation 10

focus 12, 15

Freeze 35

fuzzy image 19

## I

- image
  - display computer 9
  - display video 14
- image does not fit screen 20
- image not centered 23
- image not sharp 20
- image not square 20
- image reversed 21
- image size matrix 42
- image upside down 21
- Info
  - network 36
- IP Address 36

## K

- Keystone 12, 15

## L

- lamp replacement 38
- lamp won't turn on 22
- Language 36
- laptop
  - connecting 7
  - external video port 9
- LED
  - blinking green 16
  - blinking red 22
  - solid green 16
  - solid red 22
- LED behavior 16
- lens
  - changing 37
  - cleaning 37
- leveling foot 12
- Low Power 33

## M

- Main menu 29
- menu system 29
- Monitor connector 7
- mouse, using your 7
- Mute 35

## N

- Network 36
- Network connector 8
- Network Info 36
- no computer image 18
- no startup screen 17

## O

- only startup screen appears 17
- optional accessories 41

## P

- Picture in Picture 35
- Picture menu 30
- PiP 35
- Power button 14
- power cable 7, 13
- Power Save 33
- PowerPoint
  - remote's mouse buttons 25
- presentation features 27
- projector
  - connector panel 6
  - customizing 28
  - optional accessories 41
  - shutdown 16
  - standard accessories 41
  - troubleshooting problems 16
- projector height 12, 14
- projector positioning 12, 14

## **R**

- Rear 33
- remote control 25
  - not working 19
- replacing the lamp 38
- RS-232
  - cable 8
  - connecting 6

## **S**

- screen trigger 6
- security lock 40
- serial connection 6
- Settings menu 33
- shutdown
  - projector 16
- solid green 16
- solid red 16
- Source 35
- Source troubleshooting 17
- Sources 33
- standard accessories
  - projector 41
- Subnet mask 36
- S-video connector 13

## **T**

- Tint 15
- trigger, screen 6
- Troubleshooting 16, 17

## **U**

- USB, using your mouse 7

## **V**

- Video button 14
- video connections
  - optional 13
  - standard 13
- Video connector 13
- video images
  - optimizing 28

## **W**

- warranty 23, 47
- Windows 2000 11
- Windows 98 10
- Windows ME, XP 11

## **X**

- XGA 5

## **Z**

- zoom 12, 15, 35

## IF YOU NEED ASSISTANCE....

For all types of Service and Support information on our products and services please go to our website at **[www.askproxima.com](http://www.askproxima.com)**

Many resources are available on our website.  
Some examples are:

- Frequently Asked Questions about general projector usage and technical issues
- E-mail support
- Online product registration
- Product data sheets
- Optional accessories
- Technical specifications, interactive image size calculator, laptop activation commands and more!

**ASK Proxima®**



# C410/C420

**InFocus Corporation**

27700B SW Parkway Avenue  
Wilsonville, Oregon 97070-9215  
1-800-294-6400 • 503-685-8888  
Fax: 503-685-8887  
<http://www.infocus.com>

**In Europe:**

InFocus International B.V.  
Strawinskylaan 585  
1077 XX Amsterdam, The Netherlands  
Phone: +31 20 579 2000  
Fax: +31 20 579 2999

**In Asia:**

238A Thomson Road  
#18-01/04 Novena Square  
Singapore 307684  
Telephone: (65) 6334-9005  
Fax: (65) 6333-4525



010-0453-01

# ASK Proxima®

**InFocus®**  
C O R P O R A T I O N